

Varenummer: 01010471
 Beskrivelse: Seeger låsering A 30 DIN 471
 Rustfast 411
 Note: Monteres med ZGA tang

Mål

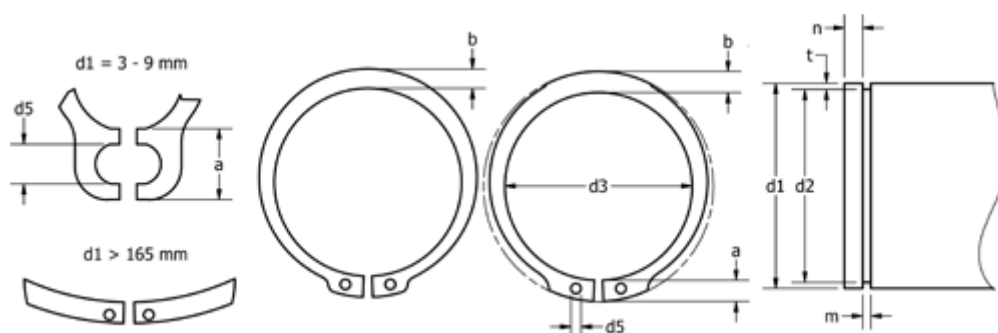

a max	= 5,0	FN kN	= 10.7	s	= 1.50
AN mm ²	= 64.0	FRg kN	= 7.65	t	= 0.70
b	= 3.5	FR kN	= 32.10	Tang	= ZGA-2
Betegnelse	= A30	g	= 1.5	tol	= -0.06
d1	= 30	K kN-mm	= 64.20	tol	= +0,21-0,42
d2	= 28.6	m min	= 1.60	tol	= -0.21
d3	= 27.9	n abl x 1000	= 19.0	vægt kg/1000	= 3.320
d5 min	= 2.0	Nominel træk	= 2.1		